



JCH

BEAUTY ACCESS





EDITO

JCH Beauty Access est la marque propre du groupe JCH International.

JCH Beauty Access couvre un très large assortiment de produits :

- **Soin et beauté du visage**
- **Beauté des mains et des pieds**
- **Gamme Spécial Homme**
- **Gamme Ergonomie**
- **Gamme Professionnelle**
- **Gamme de Voyage**

Chaque produit peut être vendu sous votre marque ou packagé de manière sobre et élégante pour une vente professionnelle, en France et à l'international, aussi bien dans des instituts et des pharmacies que dans des boutiques.

JCH Beauty Access is JCH International group trade- mark.

JCH Beauty Access covers a wide range of products:

- Facial care and beauty
- Beauty for hands and feet
- Special men's range
- Ergonomics range
- Professional range
- Travel range

Each product can be sold under your own brand label or packaged simply and elegantly for a professional sale in France or abroad, in beauty institutes and pharmacies as well as in stores.

SOM- MAIRE

SUMMARY



P.6-13 GAMME VISAGE **P.6-13 FACE CARE RANGE**

- Un large choix de pinces à épiler, miroir et autres recourbes cils...
- A wide choice of tweezers, mirrors and eyelash curler...



P.24-25 GAMME HOMME **P.26-27 MEN'S RANGE**

- Le nécessaire visage et mains design et élégant de Monsieur.
- The elegant, designer face and hand care kit for gentlemen.

P.14-19 GAMME MAINS **P.14-19 HANDS CARE RANGE**

- Coupe-ongles, ciseaux, pinces cuticules... Pour des doigts de fée.
- Nail clippers, scissors, cuticule trimmers... for fairy-like finger.

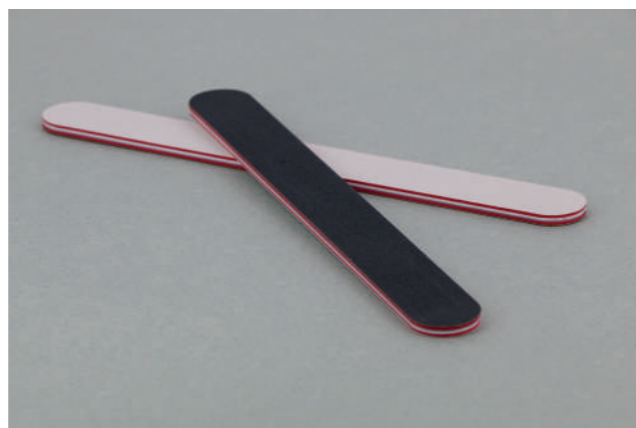

P.26-27 GAMME SPÉCIFIQUE **P.26-27 SPECIFIC CARE**

- Ciseaux bébés, ciseaux pansements ou encore des vernis, un produit spécifique pour chaque utilisation.
- Baby scissors, pandage scissors or nail care, a specific product for each use.



P.20-23 GAMME PIEDS **P.20-23 FOOT CARE RANGE**

- Râpe, pince à ongles, séparateur d'orteils... la pédicure sur le bout des ongles.
- Foot file, nail clippers, toe separators... a pedicure at your fingertips.



P.28-39 PRÉSENTOIRS **P.28-39 DISPLAYS**

GAMME VISAGE

FACE CARE

LES PINCES À ÉPILER - TWEEZERS



RÉF : 318BT-JCHBA2

- Pince à épiler mors biaux noire - 9cm - Existe aussi en aqua, lilas et corail
- Slanted tweezer satin finish - 9cm - Also available in aqua, lilac and coral



RÉF : 318CT/N-JCHBA2

- Pince à épiler mors droit noire - 9cm
- Black straight tweezer - 9cm



RÉF : 318CRABT/N-JCHBA2

- Pince à épiler mors crabe noire - 9cm
- Black tong tweezer - 9cm



NOTRE MEILLEUR QUALITÉ/PRIX - BEST VALUE FOR MONEY

- Acier inox / Stainless steel
- Bonne prise en main / Good grip



RÉF : 318BT/2-JCHBA2

- Pince à épiler mors biaux finition brossée - 9cm
- Slanted tweezer satin finish - 9cm



RÉF : 318CT/2-JCHBA2

- Pince à épiler mors droit finition brossée - 9cm
- Straight tweezer satin finish - 9cm

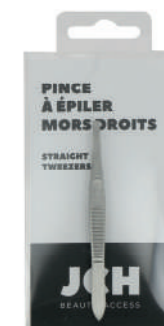

RÉF : 318CRABT/2-JCHBA2

- Pince à épiler mors crabe finition brossée - 9cm
- Tong tweezer satin finish - 9cm



GAMME PROFESSIONNELLE - PROFESSIONAL RANGE

- **Acier inox / Stainless steel**
- **Finesse des mors / Sharp tips**
- **Souplesse du ressort / Soft spring**



RÉF : 3BTPRO/2-JCHBA2

- **Pince à épiler pro mors biais finition brossée - 9,5cm - Existe aussi en noir (réf : 3BTPRO/N-JCHBA2)**
- Slanted pro tweezer satin finish - 9,5cm - Also available in black (réf : 3BTPRO/N-JCHBA2)



RÉF : 4CTPRO/2-JCHBA2

- **Pince à épiler pro mors droit finition brossée - 9,5cm**
- Straight pro tweezer satin finish - 9,5cm



RÉF : 4CCRABTPRO2-JCHBA2

- **Pince à épiler pro mors crabe finition brossée - 9cm - Existe aussi en noir (réf : 4CCRABTPRON-JCHBA2)**
- Tong pro tweezer satin finish - 9cm - Also available in black (réf : 4CCRABTPRON-JCHBA2)



RÉF : 5PPRO/2-JCHBA2

- **Pince à épiler pro écharde pointue finition brossée - 9cm**
- Pointed pro tweezer satin finish - 9cm



PINCE À ÉPILER - TWEEZERS

- **Acier inox / Stainless steel**
- **Touché soft / Soft touch**
- **Repose doigt / Finger rest**



RÉF : 3BTS/NEW-JCHBA2

- **Pince à épiler mors biais finition touché soft noire - 9cm - Existe aussi en aqua, lilas et corail**
- Black slanted tweezer soft touch finish - 9cm - Also available in aqua, lilac and coral



RÉF : 3BTP-JCHBA2

- **Pince à épiler mors biais avec repose doigt noir - 9.5cm - Existe aussi en aqua, lilas et corail**
- Slanted tweezer with black finger rest - 9.5cm - Also available in aqua, lilac and coral



RÉF : 3BTPC-JCHBA2

- **Pince à épiler mors biais finition touché soft noire avec repose doigt fuchsia - 9.5cm - Existe aussi en aqua, lilas et corail**
- Black slanted tweezer soft touch finish with fuchsia finger rest - 9.5cm - Also available in aqua, lilac and coral

LES ACCESSOIRES - ACCESSORIES



RÉF : 100RCPN-DOYPACK 

- Recourbe-cils et ses 3 recharges - 10.8cm
- Eyelash curler and 3 refills - 10.8cm



RÉF : CUROR2BTE 

- Boite de 2 cotons-tiges en silicone existe aussi en Rose clair, kaki, gris et lilas. (Vendu en présentoir p.38)
- Kit of 2 Silicone cotton swabs. Also available in light pink, khaki, grey and lilac. (See display p.38)



RÉF : NET/PM-BTEJCHBA 

- Nettoyeur de pinceaux en silicone
- Silicone makeup brush cleaner



RÉF : TCNOIR-DOYPACK 

- Taille-crayon 2 trous - Ø 7mm et Ø 11mm
- Sharpener with 2 holes - Ø 7mm and Ø 11mm



RÉF : CUROR2-JCHBA2 

- Lot de 2 cure-oreilles - 9cm
- Set of 2 earpicks - 9cm



RÉF : AT/2-JCHBA2 

- Tire-comédons en acier inoxydable - 11cm
- Blackhead removers in stainless steel - 11cm



RÉF : MG10 

- Miroir grossissant x10 - Ø 10.5cm
- Multi magnification mirror x10 - Ø 10.5cm



INCROYABLE ! IL DÉMAQUILLE AUSSI BIEN LE MASCARA QUE LE FOND DE TEINT !
INCREDIBLE PRECISION ! REMOVES BOTH MASCARA AND FOUNDATION !



RÉF : LOT2BB-DOYPACK 

- Lot de 2 éponges maquillage sans latex
- Set of 2 make-up sponges latex free



RÉF : BBLENDERPM/TBEJCHBA 

- Éponge maquillage sans latex
- Make-up sponge latex free



RÉF : GANTDEM-DOYPACK 

- Gant démaquillant 100% microfibre
- Make-up remover mitt 100% microfiber

Écologique & économique : Fini cotons, lotions, laits démaquillants... juste de l'eau !
 Eco-friendly & economical : no more wipes, lotions or cleansing milks... just water !

Pour tous types de peaux : Il aide au renouvellement cellulaire grâce à l'action exfoliante tout en douceur de ses microfibres.
 For all skin types : encourages cellular renewal by the gentle exfoliating action of its microfibres.

Tenue parfaite au poignet : Assurée par sa bande élastique.
 The elastic band provides a perfect fit to the wrist.



RÉF : EMSLOT2-BTEJCHEXP 

- 2 éponges silicone - 4.5x6.2x1cm
- Set of 2 silicone sponges - 4.5x6.2x1cm



RÉF : EKONJAC-DOYPACK 

- Éponge konjac naturelle - Ø 7.5cm
- Natural konjac sponge - Ø 7.5cm

COMMENT L'UTILISER ? - HOW TO USE THE GLOVE ?



1 Passez votre gant sous l'eau.
 / Run your glove under water.

2 Nettoyez doucement votre visage en commençant par les yeux.
 / Gently clean your face, starting with the eyes.

3 Rincez votre gant à l'eau savonneuse.
 / Rinse out your glove in soapy water.

4 Suspendez le par son crochet de séchage.
 / Hang up the glove by its drying hook.

ALLIÉ DE VOTRE QUOTIDIEN, IL VOUS SUIVRA AUSSI PARTOUT DANS VOS VOYAGES !
PART OF YOUR DAILY ROUTINE, IT CAN ALSO TRAVEL WITH YOU !



GAMME MAINS

HANDS CARE

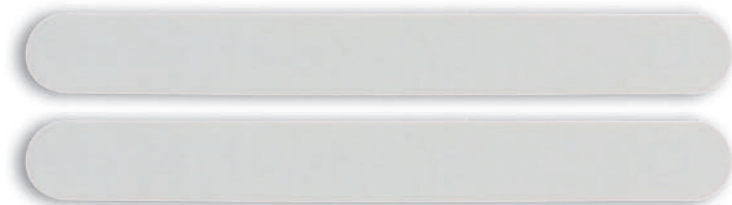

RÉF : CEFPBL-JCHBA1 

- Lot de 2 limes emeri professionnelles - 18cm - blanche #100/100
- Set of 2 pro Emery nail files white 100/100 - 18cm



RÉF : CEFPNBL-JCHBA1 

- Lot de 2 limes emeri professionnelles - 18cm noire/blanche #320/240
- Set of 2 pro Emery nail files black 320/white 240 - 18cm

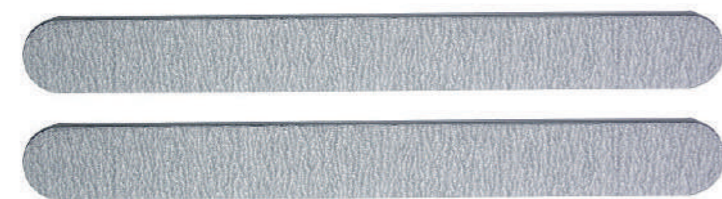

RÉF : CEFPG-JCHBA1 

- Lot de 2 limes emeri professionnelles - 18cm grise #180/180
- Set of 2 pro Emery nail files grey 180/180 - 18cm



RÉF : CEFPNBL9CM-JCHBA1 

- Lot de 2 limes emeri professionnelles - 9cm blanche/noire #240/320
- Set of 2 pro Emery nail files white 240/black 320 - 9cm



RÉF : LEC12-JCHBA1

- Lot de 2 fagots de 10 limes cartonnées noires- 12cm #150 - Existe aussi en aqua, lilas et corail
- 2 sets of 10 black carboard nail files - 12cm - Also available in aqua, lilac and coral



RÉF : EN-JCHBA1

- Lime saphir manche noir - 15cm - Existe en manche blanc (Réf : EBL-JCHBA1)
- Saphir nail file black handle - 15cm - Also available with white handle (Réf : EBL-JCHBA1)



RÉF : LC14-JCHBA1

- Lime en verre traitée antichoc noire - 14cm - Existe aussi en lilas et corail
- Glass bohemia crystal nail file black color - 14cm - Also available in lilac and coral





RÉF : MSB-JCHBA1

- Lot de 2 polissoirs - 18cm #400/4000 - Existe aussi en lilas (réf : MSBFLUO/VIOLET-JCHBA2)
- Set of 2 nail buffers #400/4000 - 18cm - Also available in lilac (réf : MSBFLUO/VIOLET-JCHBA2)

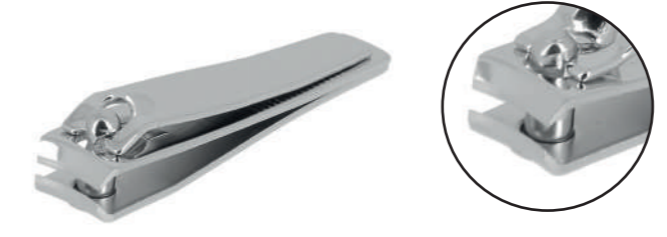

RÉF : 2096/1-JCHBA2

- Coupe-ongles manucure levier brillant - 6cm
- Manicure nail clipper with lever shiny finition - 6cm



RÉF : 4WBB-DOYPACK

- Polissoir bloc 4 faces qualité expert - 9x3x3cm - #240#320#800#3000
- Nail buffer block - 9x3x3cm - #240#320#800#3000

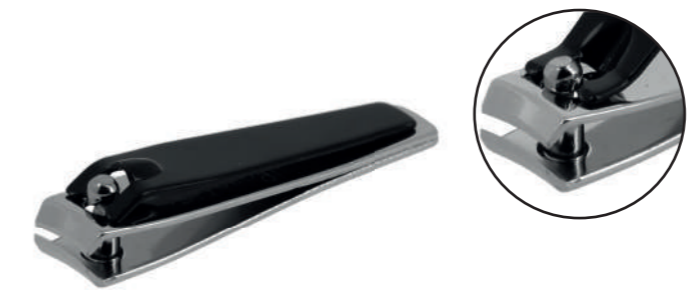

RÉF : 2096-JCHBA2

- Coupe-ongles manucure levier noir - 6cm - Existe aussi en aqua, lilas et corail
- Manicure nail clipper with black lever - 6cm - Also available in aqua, lilac and coral



RÉF : TCTBOIS-JCHBA0

- Lot de 10 batonnets bois repousse cuticules - 11cm
- Set of 10 birchwood sticks cuticles pusher - 11cm



RÉF : 2089-JCHBA2

- Coupe-ongles manucure avec réservoir noir - 6.5cm- Existe aussi en aqua, lilas et abricot
- Black manicure nail clipper with catcher - 6.5cm - Also available in aqua, lilac and apricot



RÉF : RCCSN-JCHBA0

- Repousse-coupe cuticules soft touch noir - 12,5cm
- Black cuticles pusher & trimmer soft touch finish- 12,5cm



RÉF : 2081/2-JCHBA2

- Coupe-ongles manucure finition brossée - 6cm
- Manicure nail clipper satin finish - 6cm





RÉF : 7040M-JCHBA2 

- Ciseaux cuticules courbe finition brillante - 10cm - Existe aussi en finition brossée
- Curved cuticle scissors shiny finish - 10cm - Also available in satin finish



RÉF : 7020M-JCHBA2 

- Ciseaux à ongles magic métal courbe finition brillante - 10cm - Existe aussi en finition brossée
- Curved nail scissors shiny finish - 10cm - Also available in satin finish



RÉF : 1108.3.2R-JCHBAO 

- Pince cuticule 11 cm - bec 3mm 2 ressorts - mors affutés
- Cuticle nipper 2 springs jaw 3mm - 11cm - sharp tips

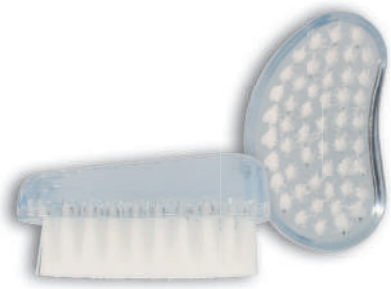

RÉF : BOCRISTAL-DOYPACK 

- Brosse à ongles ovoïde translucide - 7x4x3.5cm
- Translucent nail brush - 7x4x3.5cm



GAMME PIEDS

FOOT CARE

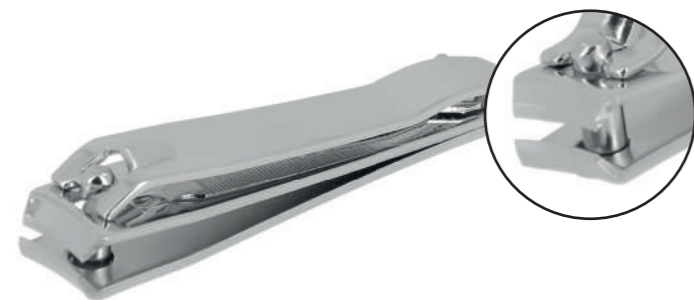

RÉF : 2085/1-JCHBAO 

- Coupe-ongles pédicure levier brillant - 8cm
- Pedicure nail clipper with lever shiny finition - 8cm



RÉF : 2087-JCHBAO

- Coupe-ongles pédicure brillant avec réservoir noir - 8,5cm - Existe aussi en aqua, lilas et abricot
- Shiny pedicure nail clipper with black catcher - 8,5cm - Also available in aqua, lilac et apricot

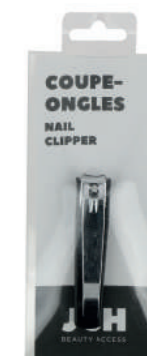

RÉF : 2085-JCHBAO

- Coupe-ongles pédicure levier noir - 8cm - Existe aussi en aqua, lilas et corail
- Pedicure nail clipper with black lever - 8cm - Also available in aqua, lilac et coral



RÉF : 1036.2R/2-JCHBAO 

- Pince à ongles pédicure 2 ressorts avec fermoir finition brossée - 13,5cm
- Pedicure nail nipper 2 springs with lock - satin finish - 13,5cm

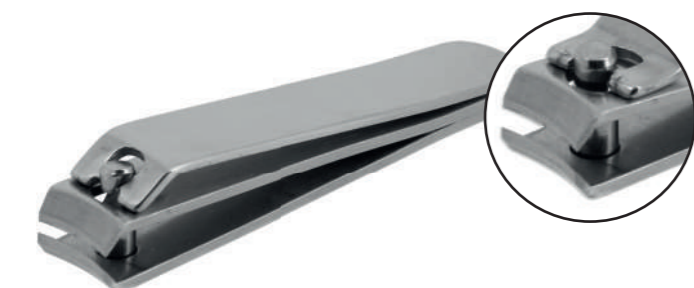

RÉF : 2082/2-JCHBAO 

- Coupe-ongles pédicure finition brossée - 8cm
- Pedicure nail clipper satin finish - 8cm



RÉF : 1145.2R/1-JCHBAO 

- Pince à ongles pédicure 2 ressorts avec fermoir finition brillante - 12cm
- Pedicure nail nipper 2 springs with lock - shiny finish - 12cm

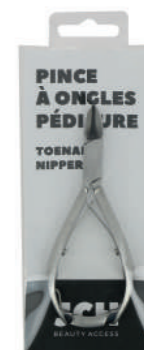



RÉF : 1170/1-JCHBA0 

- Pince à ongles sécateur ressort contois avec fermoir finition brillante - 13cm
- Pedicure nail nipper wired spring with lock - shiny finish - 13cm



RÉF : KPM-JCHBA5

- Râpe double face métal acier inox pro - 26.5cm
- Double sided inox pro foot file - 26.5cm



RÉF : KP-JCHBA1 

- Râpe pédicure emeri 2faces #80/150 noir soft touch - 18cm
- Double sided emeri foot file 80/150 soft touch finish - 18cm



RÉF : KCP 

- Râpe pédicure emeri 2faces #80/150 manche plastique blanc - 24cm
- Double sided emeri foot file 80/150 white plastic finish - 24cm



GAMME HOMME

MEN CARE



RÉF : 6130/2-JCHBAO 

- Ciseaux moustache finition brossée - 12cm
- Mustache scissors satin finish - 12cm



RÉF : 6135/2-JCHBAO 

- Ciseaux poils de nez finition brossée - 12cm
- Hair nose scissors satin finish - 12cm



RÉF : 6120/2-JCHBA2 

- Ciseaux à ongles courbes finition brossée - 8cm
- Curved nail scissors satin finish - 8cm



RÉF : TR7N 

SET DE 7 PIÈCES :

- 1 pince à épiler noire mors biaux - 9cm
- 1 pince à ongle 1 ressort tournant - 10 cm
- 1 ciseaux ongles courbe - 10cm
- 1 lime saphir touché soft - 12.5cm
- 1 coupe-ongles manucure levier noir - 6cm
- 1 polissoir - 10cm
- 1 repousse cuticules - 10cm

SET OF 7 PIECES :

- 1 slanted black tweezer - 9cm
- 1 nail clipper 1 rotating spring - 10cm
- 1 curved nail scissors - 10cm
- 1 saphir nail file soft touch finish - 12.5cm
- 1 manicure nail clipper with black lever - 6cm
- 1 nail buffer - 10cm
- 1 cuticle pusher - 10cm



RÉF : TRIM- 

- Coupe poils nez / oreilles électrique (piles incluses)
- Electric hair / nose trimmer (batteries included)

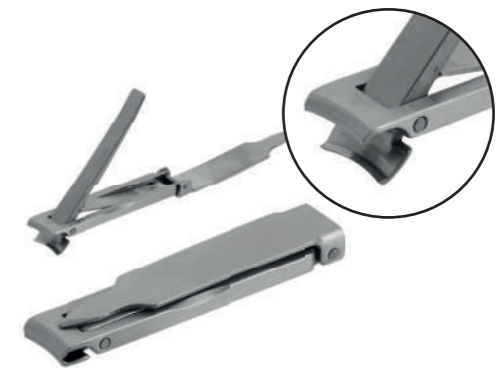

RÉF : 2080/1-JCHBA2 

- Coupe-ongles manucure finition brillante - 6cm - Existe aussi en finition brossée (réf : 2080/2)
- Manicure nail clipper shiny finish - 6cm - Also available in satin finish (ref : 2080/2)



RÉF : TR3N- JCHBAO 

SET DE 3 PIÈCES :

- 1 pince à épiler mors biaux - 9cm
- 1 ciseaux à ongles courbe - 9,5cm
- 1 lime saphir touché soft - 10cm

SET OF 3 PIECES :

- 1 slanted tweezer - 9cm
- 1 curved nail scissors - 9,5cm
- 1 saphir nail file soft touch finish - 10cm

GAMME SPECIFIQUES

SPECIFIC CARE

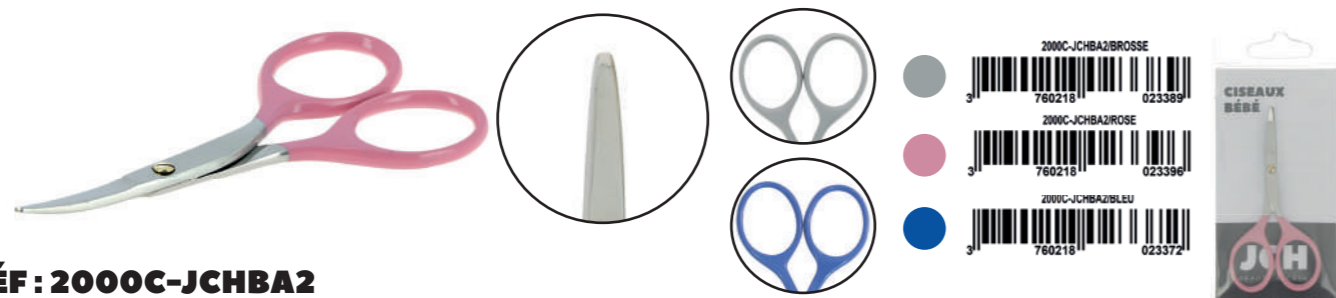

RÉF : 2000C-JCHBA2

- Ciseaux ongles bébés courbe finition brillante - 10cm - Existe aussi en brossé et en bleu
- Curved baby scissors shiny finish - 10cm - Also available in satin finish and blue



RÉF : MED14.R+P/1-JCHBAO

- Ciseaux pansements finition brillante - 14cm
- Bandage scissors shiny finish - 14cm



RÉF : 3070/1-JCHBA1

- Ciseaux coiffeur finition brillante - 17 cm
- Hair scissors shiny finish - 17 cm

3.25€



RÉF : 2000BB-JCHBA2

- Ciseaux ongles nourrisson bouts ronds - 8cm - Existe aussi en bleu
- Infant scissors rounded ends - 8cm - Also available in blue



RÉF : 2097/1-JCHBAO

- Coupe-ongles pédicure avec réservoir, acier carbone et plastique - 9.5cm
- Pedicure nail clippers with reservoir, carbon steel and plastic - 9.5cm



RÉF : SDO-1300-JCHEXP4

- Anti-stries soin des ongles 11ml
- Ridge filler 11ml



RÉF : SDO-1600-JCHEXP4

- Soins de nuit 11ml
- Nourishing night care 11ml



RÉF : 9322B/1

- Pince à ongles pédicure ergonomique 2 ressorts manche en elastomer - 14cm
- Pedicure ergonomic nail nipper 2 springs Elastomer handle - 14cm



RÉF : 2061CGA/1-JCHBA2

- Ciseaux à ongles manucure courbe finition brillante - grands anneaux - 12cm
- Curved nail scissors shiny finish - large rings - 12cm



RÉF : 2066CGA/1-JCHBA2

- Ciseaux à ongles pédicure courbe finition brillante - grands anneaux - 12cm
- Curved nail scissors shiny finish - large rings - 12cm



RÉF : 2065GA/1-JCHERG3

- Ciseaux pédicure grandes lames de 10cm finition brillante - grands anneaux - 18cm
- Nail scissors 10 cm large blades shiny finish - large rings - 18cm



PRÉSENTOIRS

DISPLAYS



P2420812082

LxLxH: 17.5x12.5x17.5cm

**12 coupe-ongles pédicure (RÉF : 2081/2)
& 12 coupe-ongles manucure (RÉF : 2082/2)**

12 pedicure nail clipper (REF : 2081/2)
& 12 manicure nail clipper (REF : 2082/2)

- **Coupe-ongles finition brossée**
- Nail clipper satin finish

RÉF : 2081/2

Coupe-ongles pédicure /
pedicure nail clipper :



RÉF : 2082/2

Coupe-ongles manucure /
manicure nail clipper :



P2420852096

LxLxH: 17.5x12.5x17.5cm

**12 coupe-ongles pédicure (RÉF : 2085/1)
& 12 coupe-ongles manucure (RÉF : 2096/1)**

12 pedicure nail clipper (REF : 2085/1)
& 12 manicure nail clipper (REF : 2096/1)

- **Coupe-ongles finition brillante**
- Nail clipper shiny finish

RÉF : 2085/1

Coupe-ongles pédicure /
pedicure nail clipper :



RÉF : 2096/1

Coupe-ongles manucure /
manicure nail clipper :





RÉF : 318BT/41
mors biais / slanted :



RÉF : 318CT/41
mors droits / straight :



RÉF : 318CRABT/41
mors crabes / tong :



P24PAEPRO/2

LXLXH: 13x9x16.5cm

18 pinces à épiler professionnelles (mors biais, droits, crabes) & 6 pinces à épiler professionnelles mors pointus

18 professional tweezers shiny finition (slanted, straight, tong) & 6 professional pointed tweezers

RÉF : 3BTPRO/2
mors biais / slanted :



RÉF : 4CTPRO/2
mors droits / straight :



RÉF : 4CCRABTPRO/2
mors crabes / tong :



RÉF : 5PPRO/2
mors pointus / pointed :



P24318T/41

LXLXH: 13x9x16.5cm

24 pinces à épiler mi-doré (mors biais, droits, crabes)

24 half gold tweezers (slanted, straight, tong)

RÉF : 318BT/1
mors biais / slanted :



RÉF : 318CT/1
mors droits / straight :



RÉF : 318CRABT/1
mors crabes / tong :



RÉF : 318PT/1
mors pointus / pointed :



P24318T/1

LXLXH: 13x9x16.5cm

18 pinces à épiler brillante (mors biais, droits, crabes) & 6 pinces à épiler mors pointus

18 tweezers shiny finition (slanted, straight, tong) & 6 pointed tweezers



P24BTPF

LXLXH: 13x9x16.5cm

24 pinces à épiler mors biais (RÉF : 3BTP)
24 slanted tweezers (REF : 3BTP)



P24318BT/FPVN

LXLXH: 13x9x16.5cm

24 pinces à épiler mors biais (RÉF : 318BT)
24 slanted tweezers (REF : 318BT)



P24BTPCF

LXLXH: 13x9x16.5cm

24 pinces à épiler mors biais (RÉF : 3BTPC)
24 slanted tweezers (REF : 3BTPC)

- Touché soft
- Soft touch



P24BTS-NEW

LXLXH: 13x9x16.5cm

24 pinces à épiler mors biais (RÉF : 3BTS/NEW)
24 slanted tweezers (REF : 3BTS/NEW)

- Touché soft
- Soft touch



P242085C

LxLxH: 17.5x12.5x17.5cm

24 coupe-ongles pédicure (RÉF : 2085)
24 pedicure nail clipper (REF : 2085)



RÉF : 2085
Coupe-ongles pédicure / pedicure nail clipper :



RÉF : 2096
Coupe-ongles manucure / manicure nail clipper :



P2420852096F

LxLxH: 17.5x12.5x17.5cm

12 coupe-ongles pédicure (RÉF : 2085) & 12 coupe-ongles manucure (RÉF : 2096)
12 pedicure nail clipper (REF : 2085) & 12 manicure nail clipper (REF : 2096)



P2420872089F

LxLxH: 17.5x12.5x17.5cm

12 coupe-ongles pédicure (RÉF : 2087) & 12 coupe-ongles manucure (RÉF : 2089)
12 pedicure nail clipper (REF : 2087) & 12 manicure nail clipper (REF : 2089)

- Coupe-ongles brillant avec réservoir - 8,5cm
- Shiny nail clipper with catcher - 8,5cm

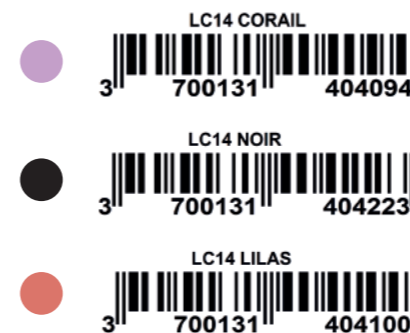

RÉF : 2087
Coupe-ongles pédicure / pedicure nail clipper :



RÉF : 2089
Coupe-ongles manucure / manicure nail clipper :



P24LC14JCH

LxLxH: 13x9x16.5cm

24 limes en verre (RÉF : LC14)
24 glass nail file (REF : LC14)

- Lime en verre traitée antichoc noire - 14cm
- Glass bohemia crystal nail file black color - 14cm



P30MSBF.V1
LXLXH: 13x12.5x21.5cm

15 polissoirs 2 faces vert (RÉF : MSB)
& 15 polissoirs 2 faces lilas (RÉF : MSBFLUO/VIOLET)
15 green nail buffer (REF : MSB)
& 15 lilac nail buffer (REF : MSBFLUO/VIOLET)

P30MSBFV2
LXLXH: 13x12.5x21.5cm

10 polissoirs 2 faces vert (RÉF : MSB)
10 polissoirs 2 faces lilas (RÉF : MSBFLUO/VIOLET)
& 10 polissoirs 2 faces corail (RÉF : MSB-FC)
10 green nail buffer (REF : MSB)
10 lilac nail buffer (REF : MSBFLUO/VIOLET)
& 10 coral nail buffer (REF : MSB-FC)



P48CEFA.
LXLXH: 13x12.5x21.5cm

16 limes motif zèbre #180/180 (RÉF : CEFA_ZEBRE+ZEBRE)
16 limes motif girafe et léopard #180/180 (RÉF : CEFA_GIRAFE+LEOP)
& 16 limes motif serpent #180/180 (RÉF : CEFA_SERPENTB+N)
16 zebra nail files (REF : CEFA_ZEBRE+ZEBRE)
16 giraffe and leopard nail files (REF : CEFA_GIRAFE+LEOP)
& 16 snake nail files (REF : CEFA_SERPENTB+N)



P48CEFP
LXLXH: 13x12.5x21.5cm

16 limes noires #100/180 (RÉF : CEFPN)
16 limes grises #180/180 (RÉF : CEFPG)
& 16 limes blanches et noires #240/320 (RÉF : CEFPN-BL)
16 black nail files (REF : CEFPN)
16 grey nail files (REF : CEFPG)
& 16 white and black nail files (REF : CEFPN-BL)



P48CEFF
LXLXH: 13x12.5x21.5cm

16 limes parmes (RÉF : CEFFLUO_P)
16 limes roses (RÉF : CEFFLUO_F)
8 limes oranges (RÉF : CEFFLUO_O)
& 8 limes vertes (RÉF : CEFFLUO_V)
16 violet nail files (REF : CEFFLUO_P)
16 pink nail files (REF : CEFFLUO_F)
8 orange nail files (REF : CEFFLUO_O)
& 8 green nail files (REF : CEFFLUO_V)



P25CUROR2BTE

- 25 boîtes de 2 cotons-tiges (RÉF : CUROR2BTE)
- 25 kit of 2 cotton swabs (REF : CUROR2BTE)



SPRAY100ML-BA

- Kit spray individuel 100ml
- Individual spray kit 100ml



P10MG10

- 10 miroirs grossissant (RÉF : MG10)
- 10 multi magnification mirror (REF : MG10)



RÉF : 2084CROCO

- Coupe-ongles bébé crocodile bleu et rose - 5.5 cm
- Pink and blue nail clipper - 5.5cm



RÉF : POT40ACR/2084CROCO

- Pot en acrylique de 40 coupe-ongles - Ø 12 x 15 cm (Possibilité de faire un mix rose et bleu)
- Acrylic pot of 40 nail clippers - Ø 12 x 15 cm (Possibility to make a pink and blue mix)



RÉF : POT100PET/2084CROC

- Pot en PET de 100 coupe-ongles - Ø 15 x 18 cm (Possibilité de faire un mix rose et bleu)
- PET pot of 100 nail clippers - Ø 15 x 18 cm (Possibility to make a pink and blue mix)



PLV-BA

- 135 produits
- 135 produits

x10



PINCE À ÉPILER MORS BIAIS
SLANTED TWEEZERS
RÉF : 3BTPRO/2-JCHBA2

x10



PINCE À ÉPILER MORS CRABE
TONG TWEEZERS
RÉF : 4CCRABTPRO2-JCHBA2

x10



PINCE À ÉPILER MORS
POINTUS
POINTED TWEEZERS
RÉF : 5PPRO/2-JCHBA2

x10



CURE-OREILLES
EAR CLINER
RÉF : CUROR2-JCHBA2

x10



CISEAUX ONGLES COURBES
CURVED NAIL SCISSORS
RÉF : 7020M-JCHBA2

x10



CISEAUX BÉBÉ
BABY SCISSORS
RÉF : 2000C-JCHBA2

x10



TIRE-COMÉDONS
COMEDON EXTRACTOR
RÉF : AT/2-JCHBA2

x6



COUPE-ONGLE PÉDICURE
PEDICURE NAIL CLIPPER
RÉF : 2087-JCHBA0

x8



CISEAUX PANSEMENTS
BANDAGE SCISSORS
RÉF : MED14.R+P/1-JCHBA0

x4



PINCE À ONGLES PÉDICURE
TOENAIL NIPPER
RÉF : 1170/1-JCHBA0

x4



PINCE À ONGLES PÉDICURE
TOENAIL NIPPER
RÉF : 1258/2-JCHBA0

x10



LIMES EMERI
NAIL FILE
RÉF : CEFPNBL-JCHBA1

x4



ÉPONGE KONJAC
KONJAC SPONGE
RÉF : EKONJAC-DOYPACK

x3



POLISSOIR 4 FACES
NAIL BUFFER
RÉF : 4WBB-DOYPACK

x3



BROSSE À ONGLES
NAIL BRUSH
RÉF : BOCRISTAL-DOYPACK

x5



MIROIR GROSSISSANT
MULTI MAGNIFICATION MIRROR
RÉF : MG10

x10



GANT DÉMAQUILLANT
MAKEUP REMOVER MITT
RÉF : GANTDEM-DOYPACK

x8



RÂPE
FOOT FILE
RÉF : KCP

PRÉSENTOIRS
DISPLAYS
DISPLAYS

JCH

BEAUTY ACCESS

**4 avenue de la Marne - Le Cartelot - Bâtiment B
59290 WASQUEHAL - FRANCE
Tél : +33(0)3 20 81 00 91**

www.jch.fr